



Installation / User Manual

APsystems YC600B Microinverter

Rev 1.1



ALTENERGY POWER SYSTEM Inc.
latam.APsystems.com

© All Rights Reserved



Please scan the QR code to get mobile app and more support to help the installation.

Table of Contents

1.Important Safety Instructions.....	2
1.1 Safety Instructions.....	2
1.2 Radio Interference Statement.....	3
1.3 Symbols replace words on the equipment, on a display, or in manuals.....	4
2.APsystems Microinverter System Introduction.....	5
3.APsystems Microinverter YC600B Introduction.....	7
4.APsystems Microinverter System Installation.....	8
4.1 Additional Installation components from APsystems.....	8
4.2 Required Parts and Tools from you.....	8
4.3 Installation Procedures.....	9
4.3.1 Step 1 - Verify the grid voltage to match with microinverter rating.....	9
4.3.2 Step 2 - The AC bus distribution.....	9
4.3.3 Step 3 - Attach the APsystems Microinverters to the racking.....	9
4.3.4 Step 4 - Ground the systems.....	10
4.3.5 Step 5 - Connect the APsystems microinverter to AC bus cable.....	10
4.3.6 Step 6 - Install a Bus Cable End Cap at the end of AC bus cable.....	11
4.3.7 Step 7 - Connect APsystems Microinverters to the PV Modules.....	11
4.3.8 Step 8 - Complete the APsystems installation map.....	12
5.APsystems microinverter system operating instructions.....	14
6.Troubleshooting.....	15
6.1 Status Indications and Error Reporting.....	15
6.1.1 Start up LED.....	15
6.1.2 Operation LED.....	15
6.1.3 GFDI Error.....	15
6.1.4 Other Faults.....	15
6.2 Troubleshooting a non-operating APsystems Microinverter.....	16
6.3 Maintenance.....	16
7.Replace a microinverter.....	17
8.Technical Data.....	18
8.1 YC600B Microinverter Datasheet.....	19
9.Wiring Diagram.....	21
9.1 Sample Wiring Diagram - Single Phase.....	21
10.YC600B Accessory.....	22
10.1 Wiring Diagram.....	22
10.2 Accessories Summary.....	23

1.Important Safety Instructions

This manual contains important instructions to follow during installation and maintenance of the APsystems Photovoltaic Grid-connected Inverter (Microinverter). To reduce the risk of electrical shock and ensure the safe installation and operation of the APsystems Microinverter, the following symbols appear throughout this document to indicate dangerous conditions and important safety instructions Specifications subject to change without notice - please ensure you are using the most recent update found at www.APsystems.com.

WARNING

This indicates a situation where failure to follow instructions may cause a serious hardware failure or personnel danger if not applied appropriately. Use extreme caution when performing this task.

NOTICE

This indicates information that is important for optimized microinverter operation. Follow these instructions closely.

1.1 Safety Instructions

- ✓ **Do NOT** disconnect the PV module from the APsystems Microinverter without first disconnecting the AC power.
- ✓ Only qualified professionals should install and/or replace APsystems Microinverters.
- ✓ Perform all electrical installations in accordance with local electrical codes.
- ✓ Before installing or using the APsystems Microinverter, please read all instructions and cautionary markings in the technical documents and on the APsystems Microinverter system and the solar-array.
- ✓ Be aware that the body of the APsystems Microinverter is the heat sink and can reach a temperature of 80°C. To reduce risk of burns, do not touch the body of the Microinverter.
- ✓ **Do NOT** attempt to repair the APsystems Microinverter. If it fails, contact APsystems Customer Support to obtain an RMA number and start the replacement process. Damaging or opening the APsystems Microinverter will void the warranty.
- ✓ Caution!
The external protective earthing conductor is connected to the inverter protective earthing terminal through AC connector. When connecting, connect the AC connector first to ensure the inverter earthing then do the DC connections. When disconnecting, disconnect the AC by opening the branch circuit breaker first but maintain the protective earthing conductor in the branch circuit breaker connect to the inverter ,then disconnect the DC inputs.
- ✓ Please install isolation switching devices on the AC side of the inverter.
- ✓ **CAUTION** – Hot surfaces - To reduce the risk of burns - Do not touch. Risk of electric shock-(a) both ac and dc voltage source are terminated inside this equipment. Each circuit must be individually disconnected before servicing, and (b) When the photovoltaic array is exposed to light, it supplies a dc voltage to this equipment. Warranty void if cover removed. No user serviceable parts inside.Refer servicing to qualified service personnel. This inverter has an integral ground-fault detector / interrupter (GFDI).This Utility-InteractiveInverter contains active anti-islanding protection(IEEE1547) .

1.Important Safety Instructions

1.2 Radio Interference Statement

The equipment could radiate radio frequency energy and this might cause harmful interference to radio communications if not following the instructions when installing and using the equipment. But there is no guarantee that interference will not occur in a particular installation. If this equipment causes harmful interference to radio or television reception, the following measures might resolve the issues:





- A) Relocate the receiving antenna and keep it well away from the equipment.

- B) Consult the dealer or an experienced radio / TV technical for help.

Changes or modifications not expressly approved by the party responsible for compliance may void the user's authority to operate the equipment.

1. Important Safety Instructions

1.3 Symbols replace words on the equipment, on a display, or in manuals

 APsystems	Trademark.
	Caution, risk of electric shock.
	Caution, hot surface.
	NOTICE, danger! This device directly connected with electricity generators and public grid.
Qualified personnel	Person adequately advised or supervised by an electrically skilled person to enable him or her to perceive risks and to avoid hazards which electricity can create. For the purpose of the safety information of this manual, a "qualified person" is someone who is familiar with requirements for safety, electrical system and EMC and is authorized to energize, ground, and tag equipment, systems, and circuits in accordance with established safety procedures. The inverter and endues system may only be commissioned and operated by qualified personnel.

2.APsystems Microinverter System Introduction

The APsystems Microinverter is used in utility-interactive grid-tied applications, comprised of three key elements:

- APsystems Microinverter
- APsystems Energy Communication Unit (ECU)
- APsystems Energy Monitor and Analysis (EMA) web-based monitoring and analysis system

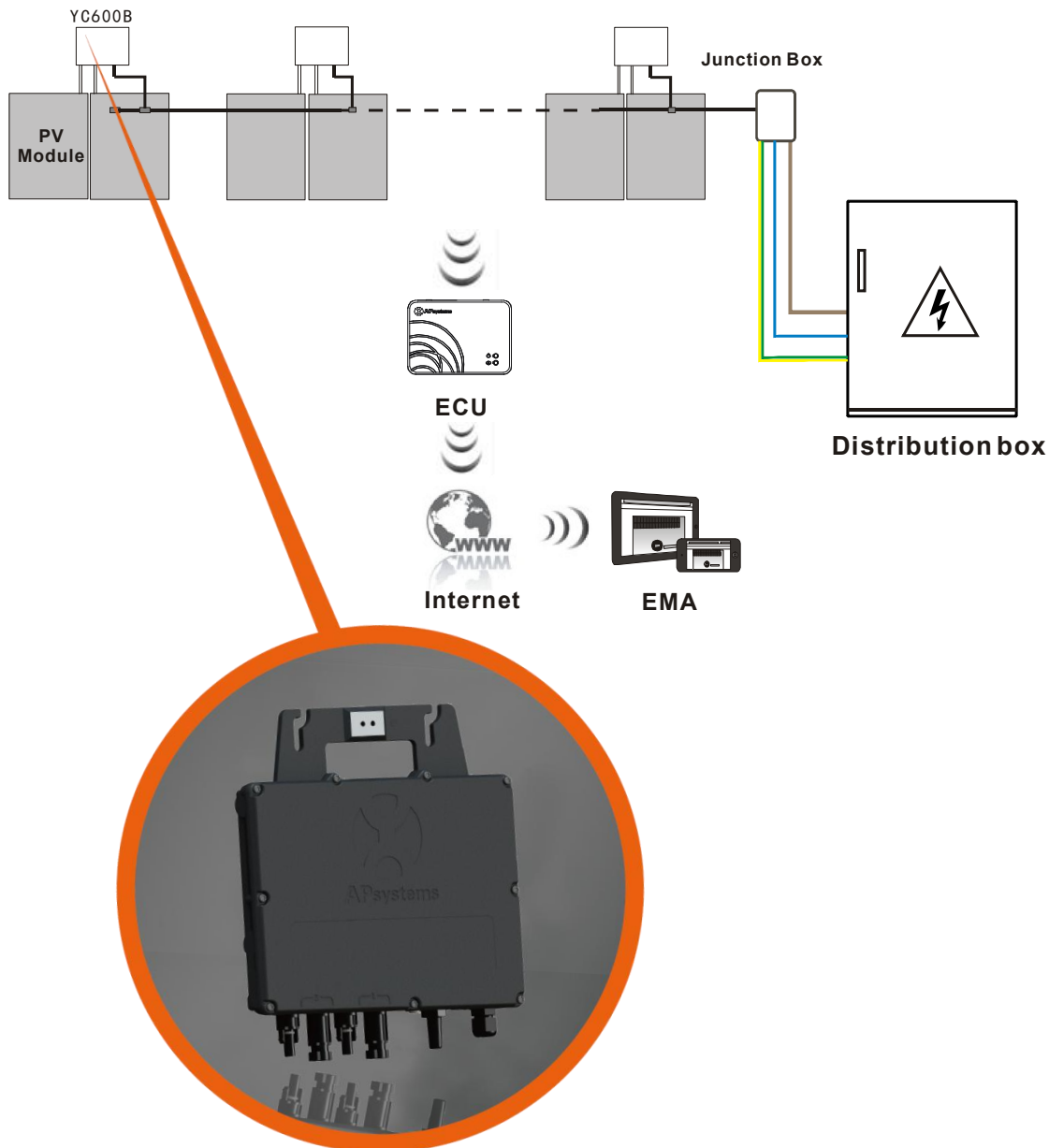

Figure 1

2. APsystems Microinverter System Introduction

This integrated system improves safety; maximizes solar energy harvest; increases system reliability, and simplifies solar system design, installation, maintenance, and management.

APsystems Microinverters maximize PV energy production

Each PV module has individual Maximum Peak Power Tracking (MPPT) controls, which ensures that the maximum power is produced to the utility grid regardless of the performance of the other PV modules in the array. When PV modules in the array are affected by shade, dust, orientation, or any situation in which one module underperforms compared with the other units, the APsystems Microinverter ensures top performance from the array by maximizing the performance of each module within the array.

More reliable than centralized or string inverters

The distributed APsystems Microinverter system ensures that no single point of system failure exists across the PV system. APsystems Microinverters are designed to operate at full power at ambient outdoor temperatures of up to 149°F (65°C). The inverter housing is designed for outdoor installation and complies with the Type 6 environmental enclosure rating.

Simple to install

You can install individual PV modules in any combination of Module quantity, orientation, different type and power rate (check our online module compatibility checker called Edecider or contact APsystems).

Smart system performance monitoring and analysis

The APsystems Energy Communication Unit (ECU) is installed by simply plugging it into any wall outlet and providing an Ethernet or Wi-Fi connection to a broadband router or modem. After installing and setting the ECU (see ECU manual), the full network of APsystems Microinverters automatically reports to the APsystems Energy Monitor and Analysis (EMA) web server. The EMA software displays performance trends, informs you of abnormal events, and controls system shutdown when it is needed. (See ECU manual for instructions.)

3.APsystems Microinverter YC600B Introduction

The APsystems YC600B Microinverters connects with the single-phase grid, and can also use multiple APsystems Microinverters in the form of single-phase grid to achieve three-phase grid, and operates with most 60 and 72 cell PV modules. Contact APsystems Customer Support for checking compatibility. For more information, please see the Technical Data page (p.18) of this manual, or sign in APsystems website to obtain a solar panel list which can match with APsystems Microinverters: www.APsystems.com

Model Number	AC grid	PV Module	Module Connector
YC600B	60Hz/120V	60,72 Cell	MC-4 Type

4. APsystems Microinverter System Installation

A PV system using APsystems Microinverters is simple to install. Each Microinverter easily mounts on the PV racking, directly beneath the PV module(s). Low voltage DC wires connect from the PV module directly to the Microinverter, eliminating the risk of high DC voltage. Installation **MUST** comply with local regulations and technical rules.

WARNING

- ① Perform all electrical installations in accordance with local electrical codes.
- ② Be aware that only qualified professionals should install and/or replace APsystems Microinverters.
- ③ Before installing or using an APsystems Microinverter, please read all instructions and warnings in the technical documents and on the APsystems Microinverter system itself as well as on the PV array.
- ④ Be aware that installation of this equipment includes the risk of electric shock.
- ⑤ Do not touch any live parts in the system, including the PV array, when the system has been connected to the electrical grid.

NOTICE

Strongly recommend to install Surge protection Devices in the dedicated meter box.

4.1 Additional Installation components from APsystems

- Bus Cable End Cap (sold separately)
- Bus Cable Y-CONN Cap (sold separately)
- Bus Cable Unlock Tool (sold separately)

4.2 Required Parts and Tools from you

In addition to your PV array and its associated hardware, you will need the following items:

- An AC connection junction box
- Mounting hardware suitable for module racking
- Sockets and wrenches for mounting hardware

4. APsystems Microinverter System Installation

4.3 Installation Procedures

4.3.1 Step 1 - Verify the grid voltage to match with microinverter rating

4.3.2 Step 2 - The AC bus distribution

- The AC bus is arranged at the proper position of the inverter.
- One end of the AC bus access junction box into power grid.
- Wire the conductors of the AC bus: L - BROWN ; N - BLUE ; PE - YELLOW GREEN**

⚠ WARNING

Wiring colour code can be different according local regulation, check all the wires of the installation before connecting to the AC bus to be sure they match. Wrong cabling can damage irreparably the microinverters, such an issue is not covered by the warranty.

⚠ WARNING

Forbidden to hand carry the inverter through AC cable.

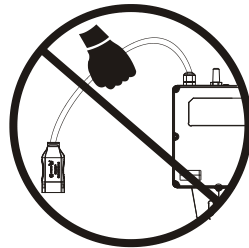

4.3.3 Step 3 - Attach the APsystems Microinverters to the racking

- Mark the location of the Microinverter on the rack, with respect to the PV module junction box or any other obstructions.
- Mount one Microinverter at each of these locations using hardware recommended by your module racking vendor. When install microinverter, grounding washer must be facing the racking.

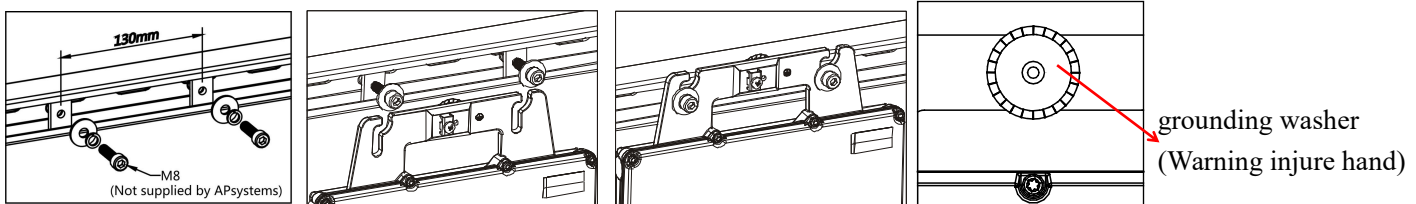

Figure 2

⚠ WARNING

Prior to installing any of the microinverters, verify that the utility voltage at the point of common connection matches the voltage rating on microinverter label.

⚠ WARNING

Do not place the inverters (including DC and AC connectors) Where exposed to the sun, rain or snow, even gap between modules. Allow a minimum of 3/4" (1.5cm.) between the roof and the bottom of the microinverter to allow proper air flow. The racking of install microinverter must be reliably grounding.

4.APsystems Microinverter System Installation

4.3.4 Step 4 - Ground the systems

- a. There already has earth wire inside the AC cable, thus the grounding work could be done directly by it.
- b. For those areas that have special requirements, the external grounding work could be done by grounding brackets.

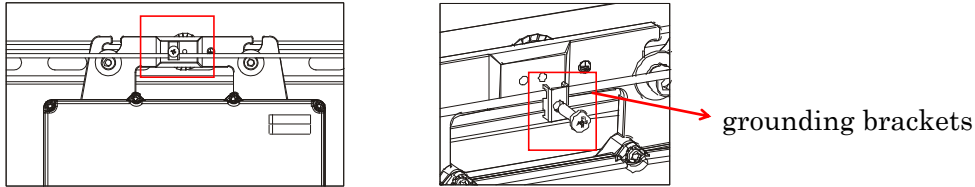

Figure 3

4.3.5 Step 5 - Connect the APsystems microinverter to AC bus cable

Push the microinverter AC connector into the trunk cable connector until you hear a "click". Try to remove it to check that it is properly locked.

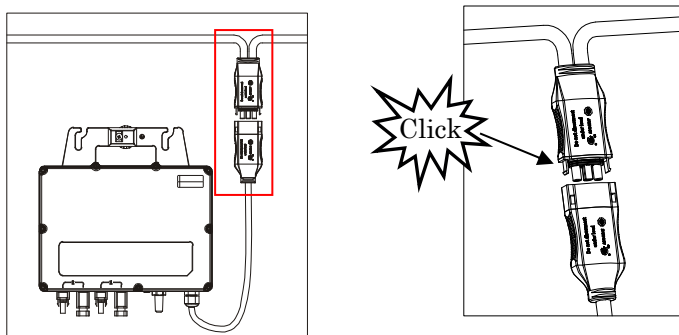

Figure 4

Best Practice: Use the Bus Cable Unlock Tool of AC Bus to split the connectors.

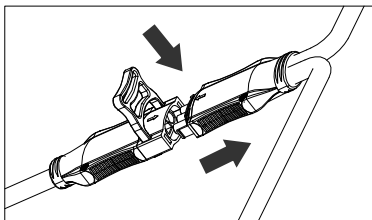

Figure 5

- a. Check the microinverter technical data page(p.18) for the maximum allowable number of microinverters on each AC branch circuit.
- b. Plug the AC connector of the microinverter into the AC bus

AC connector interface as follows.

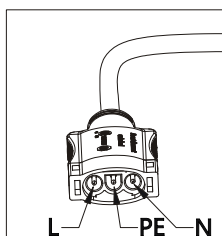

Figure 6

Cover any unused connectors with Bus Cable Y-CONN to protect the connectors.

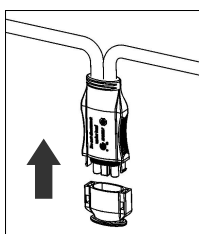
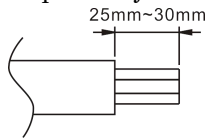

Figure 7

4. APsystems Microinverter System Installation

4.3.6 Step 6 - Install a Bus Cable End Cap at the end of AC bus cable

- a. Strip cable jacket.



- b. Insert the cable end into the seal.

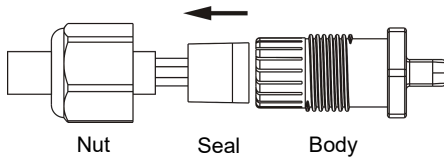

- c. Insert the wires into the cable clamps.

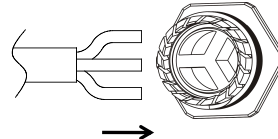

- d. Rotate the nut with 3.3N·m until the latching mechanism meets the base.

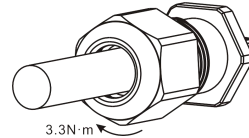

Figure 8

4.3.7 Step 7 - Connect APsystems Microinverters to the PV Modules

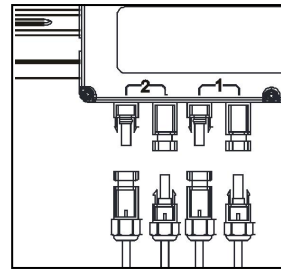
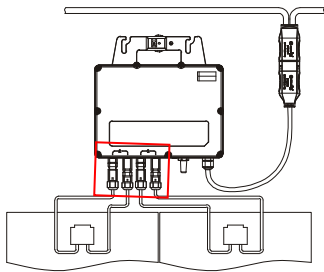

Figure 9



NOTICE

When plugging in the DC cables, the microinverter should immediately blink green three times. This will happen as soon as the cables are plugged in and will show that the microinverter is functioning correctly. This entire check function will start and end within 5 seconds of plugging in the unit, so pay careful attention to these lights when connecting the DC cables.



WARNING

Double check to make sure all of the AC and DC wiring has been correctly installed. Ensure that none of the AC and/or DC wires are pinched or damaged. Make sure that all of the junction boxes are properly closed.

4.APsystems Microinverter System Installation

4.3.8 Step 8 - Complete the APsystems installation map

Fill in the APsystems Registration Cards, which provide system information and the installation map. Feel free to provide your own layout if a larger or more intricate installation map is required. The layout map provided is designed to accommodate labels in vertical or horizontal orientation to meet all the field PV connections.

- Each APsystems Microinverter has removable serial number labels.
- Peel labels off, affix one to the respective location on the APsystems installation map, and fill in 1,2 in the label below, according to the layout on the roof.
- The other one serial number label, posted on the solar module frame is easy to view the position.

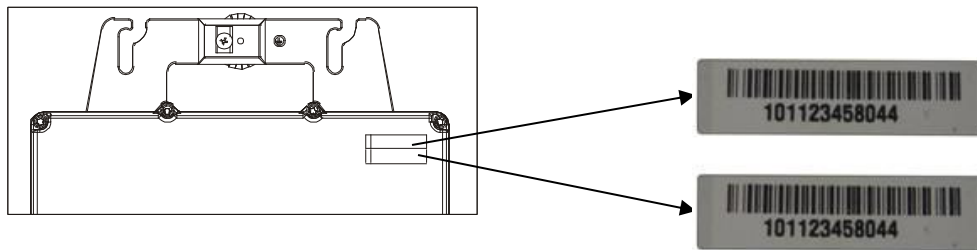

Figure 10

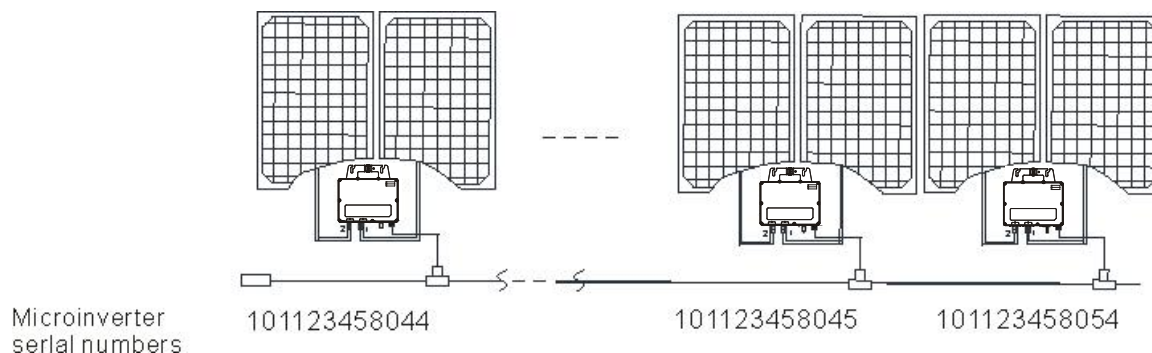

Figure 11

4. APsystems Microinverter System Installation

APsystems Microinverter & Energy Communication Unit Warranty Card

The APsystems Installation Map is a diagram of the physical location of each microinverter in your PV installation. Each APsystems microinverter has a removable serial number label located on the mounting plate. Peel the label and affix it to the respective location on the APsystems installation map.

Installation Map Template



1	2	3	4	5	6	7	8	9	10	11	12	13	14	15	16	17	18	19	20	21	22	
																						
2	1	2	1							2	1											

Figure 12

NOTICE

- ①. The layout of the inverters' serial numbers on the warranty card is only suitable for general arrangement.
- ②. Warranty card is located in Appendix last page of this manual.
- ③. You can use Scanning Gun or mobile phone to scan the serial numbers on the map when set ECU (see ECU manual).
- ④. **Using APsystems' mobile app ArrayApp can make the installation and registration much more simple.**

5. APsystems microinverter system operating instructions

To operate the APsystems microinverter PV system:

1. Turn ON the AC circuit breaker on each microinverter AC branch circuit.
2. Turn ON the main utility-grid AC circuit breaker. Your system will start producing power after a two-minute waiting time.
3. The units should start blinking green every 2 seconds five minutes after turning on the AC circuit breaker. This means they are producing power normally, but have not yet connected to the ECU. After the ECU has been plugged in, setup acknowledges the Microinverters, they will start to blink green every 10 seconds.
4. Plug in the ECU and follow the instructions according to the manual for the ECU.
5. The APsystems Microinverters will start to send performance data to the ECU. The time required for all the Microinverters in the system to report to the ECU will vary with the number of Microinverters in the system. You can verify proper operation of the APsystems Microinverters via the ECU. See the ECU Installation and Operation Manual for more information.

6.Troubleshooting

Qualified personnel can use the following troubleshooting steps if the PV system does not operate correctly:

6.1 Status Indications and Error Reporting

6.1.1 Start up LED

One quick red light followed by three short green blinks when DC power is first applied to the Microinverter indicates a successful Microinverter startup.

6.1.2 Operation LED

Flashing Slow Green (10 sec. gap) - Producing power and communicating with ECU

Flashing Fast Green (2 sec. gap) - Producing power and not communicating with ECU over 60mins

Flashing Red - Not producing power

Steady Red - Electrode assembly ground fault protection

6.1.3 GFDI Error

A solid red LED indicates the Microinverter has detected a Ground Fault Detector Interrupter (GFDI) error in the PV system. Unless the GFDI error has been cleared, the LED will remain red and the ECU will keep reporting the fault.

After the ground fault error is fixed, follow the instructions in the ECU Installation and Operation Manual to clear this GFDI error reporting.

6.1.4 Other Faults

All other faults are reported to the ECU. Refer to the ECU Installation and Operation Manual for a list of additional faults and troubleshooting procedures.

WARNING

Only qualified personnel should directly handle the APsystems Microinverter.

WARNING

- ①. Never disconnect the DC wire connectors under load. Ensure that no current is flowing in the DC wires prior to disconnecting.
- ②. Always disconnect AC power before disconnecting the PV module wires from the APsystems Microinverter.
- ③. The APsystems Microinverter is powered by PV module DC power. AFTER disconnecting the DC power, when reconnecting the PV modules to the Microinverter, be sure to watch for the three short LED flashes.

6.Troubleshooting

6.2 Troubleshooting a non-operating APsystems Microinverter

There are two possible overall areas of trouble:

- A. The Microinverter itself may be having problems.
- B. The Microinverter itself is working fine but it is having trouble communicating with the ECU. The items below refer to Microinverter issues, not communication issues (addressed in the ECU manual).

A quick way to tell whether the issue is the Microinverter or a communication problem with the ECU:

1. **Diagnosing from the Microinverter:** A red light:
 - a. A blinking red light means microinverter problem or AC connection problem.
 - b. A solid red light means ground fault detector interrupter error.
2. **Diagnosing from the ECU:**
 - a. **No-Data-Display:** This is probably a communication issue- not a Microinverter problem.
 - b. **Problems with erratic display:** Data is displayed for some period and then no data is displayed: most likely a communication issue.
 - c. **0 watts, or 2 watts:** Possibly a Microinverter problem
 - d. **Erratic data display** that is not coordinating with data displays from other units: most likely a Microinverter problem.

To troubleshoot a non-operating APsystems Microinverter, Follow the steps below in order:

1. Verify the utility voltage and frequency are within ranges shown in the Technical Data section of this manual.
2. Check the connection to the utility grid. Verify utility power is present at the inverter in question by removing AC, then DC power. **Never disconnect the DC wires while the microinverter is producing power.** Re-connect the DC module connectors and watch for three short LED flashes.
3. Check the AC branch circuit interconnection between all the microinverters. Verify each inverter is energized by the utility grid as described in the previous step.
4. Make sure that any AC breaker are functioning properly and are closed.
5. Check the DC connections between the microinverter and the PV module.
6. Verify the PV module DC voltage is within the allowable range shown in the Technical Data of this manual.
7. If the problem persists, please call APsystems Customer Support.

WARNING

Do not attempt to repair the APsystems microinverter. If troubleshooting methods fail, please return the microinverter to your distributor for replacement.

6.3 Maintenance

No need to Maintenance.

7. Replace a microinverter

Follow the procedure to replace a failed APsystems Microinverter

- A. Disconnect the APsystems Microinverter from the PV Module, in the order shown below:
 1. Disconnect the AC by turning off the branch circuit breaker.
 2. Disconnect the inverter AC connector from the AC Bus.
 3. Disconnect the PV module DC wire connectors from the microinverter.
 4. Remove the Microinverter from the PV array racking.

- B. Install a replacement Microinverter to the rack. Remember to observe the flashing LED light as soon as the new Microinverter is plugged into the DC cables.

- C. Connect the AC cable of the replacement Microinverter to the AC bus.

- D. Close the branch circuit breaker, and verify operation of the replacement Microinverter.

8. Technical Data

WARNING

- ①. Be sure to verify the voltage and current specifications of your PV module match with those of the Microinverter. Please refer to the datasheet or usermanual which can be download from APsystems website www.APsystems.com.
- ②. You must match the DC operating voltage range of the PV module with the allowable input voltage range of the APsystems Microinverter.
- ③. The maximum open circuit voltage of the PV module must not exceed the specified maximum input voltage of the APsystems.

8.1 YC600B Microinverter Datasheet

Model	YC600B
Input Data (DC)	
Recommended PV Module Power (STC) Range	250Wp-375Wp+
MPPT Voltage Range	22-48V
Operation Voltage Range	16-60V
Maximum Input Voltage	60V
Maximum Input Current	12A x 2
Maximum Input Short Circuit Current	13.2A
Output Data (AC)	
Maximum Continuous Output Power	550W
Peak Output Power	600VA
Nominal Output Voltage/Range	120V/95-155V
Adjustable Output Voltage Range	90-160V
Nominal Output Current	4.57A
Nominal Output Frequency/Range	60Hz/57-62Hz
Adjustable Output Frequency Range	55.1-64.9Hz
Power Factor(Adjustable)	>0.99
Total Harmonic Distortion	<3%
Maximum Units Per Branch	3units per 20A AC breaker/4units per 25A AC breaker
Efficiency	
Peak Efficiency	95%
CEC Efficiency	96.5%
Nominal MPPT Efficiency	99.5%
Night Power Consumption	20mW
Mechanical Data	
Operating Ambient Temperature Range	-40°F to +149 °F (-40 °C to +65 °C)
Storage Temperature Range	-40°F to +185 °F (-40 °C to +85 °C)
Dimensions (W x H x D)	10.3" × 7.4" × 1.3" (260mm X 188mm X 31.5mm)
Weight	5.7lbs(2.6kg)
AC Bus Maximum Current	20A(2.5mm ²)
Connector Type	MC4 Type
Enclosure Environmental Rating	Type 6/IP67
Cooling	Natural Convection - No Fans
Overvoltage Category	OVC II For PV Input Circuit, OVC III For Mains Circuit
Utility Interconnection Voltage And Frequency Trip Limits And Trip Times	See NOTE 1 Below
Trip Limit And Trip Time	Voltage +/-2V
Accuracy	Frequency +/-0.1Hz
	Alternate Trip times See NOTE 1 Below
Features	
Communication (Inverter To ECU)	Wireless
Transformer Design	High Frequency Transformers, Galvanically Isolated
Monitoring	Via EMA* Online Portal
Warranty	10 Years Standard
Certificate&Compliance	
Compliance	UL1741;CSA C22.2 No. 107.1-16;IEEE1547

8.1 YC600B Microinverter Datasheet

Note 1: Utility Interconnection Voltage and Frequency Trip Limits and Trip Times

Voltage and frequency limits for utility Interaction				
Condition	Simulated utility source		Maximum time (sec) (cycles) at 60 Hza before cessation of current to the simulated utility	Trip time accuracy
	Voltage (V)	Frequency (Hz)		
A	$< 0.50 V_{nor}$	Rated	80ms	+/-80ms
B	$0.50 V_{nor} \leq V < 0.88 V_{nor}$	Rated	1000ms	+/-200ms
C	$1.10 V_{nor} < V < 1.20 V_{nor}$	Rated	1000ms	+/-200ms
D	$1.20 V_{nor} \leq V$	Rated	80ms	+/-80ms
E	Rated	$f > 60.5$	160ms	+/-200ms
F	Rated	$f < 59.3$	160ms	+/-200ms

*APsystems online Energy Management Analysis (EMA) platform

Specifications subject to change without notice.

2020/3/11 REV1.1

© All Rights Reserved

9.Wiring Diagram

9.1 Sample Wiring Diagram - Single Phase

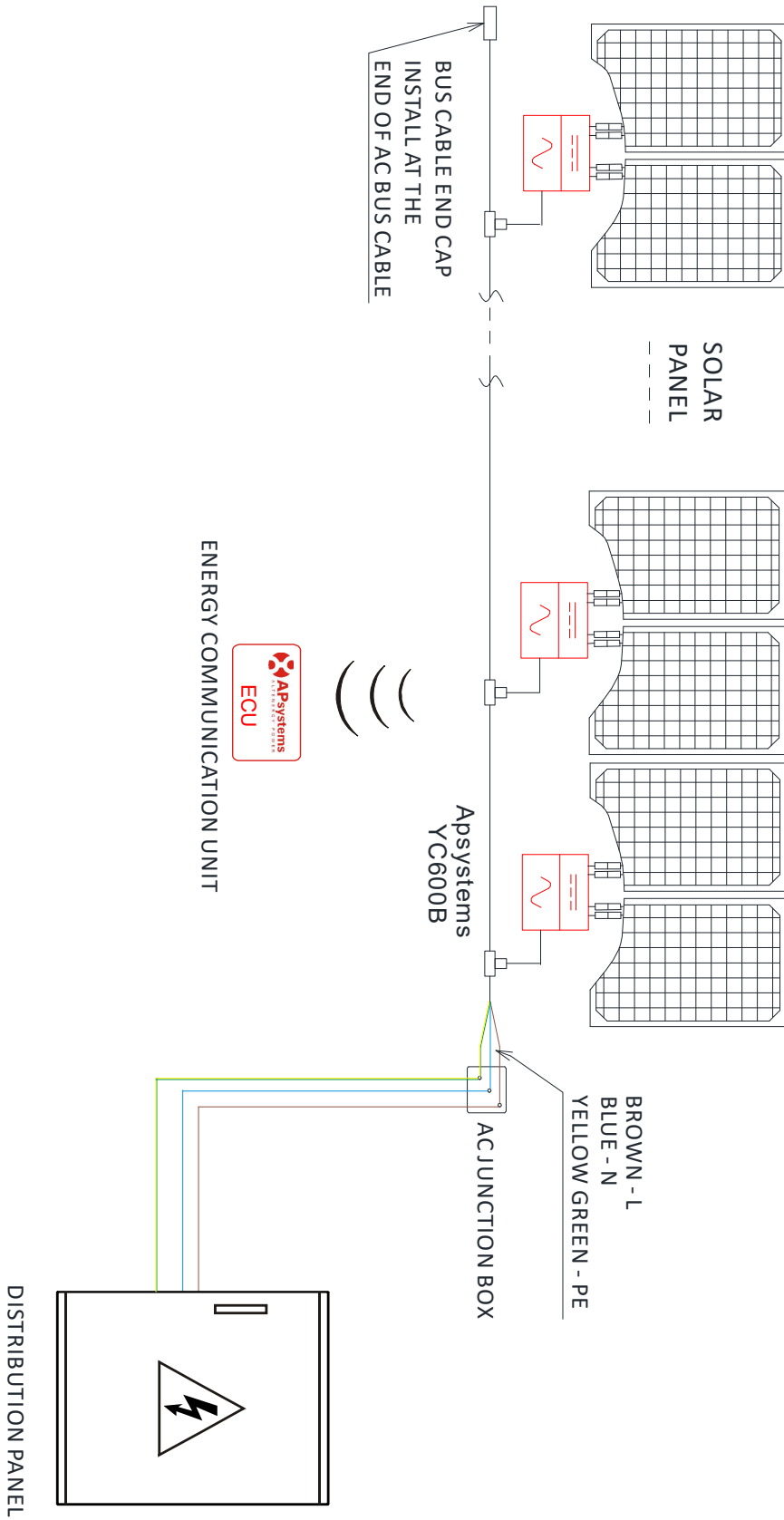
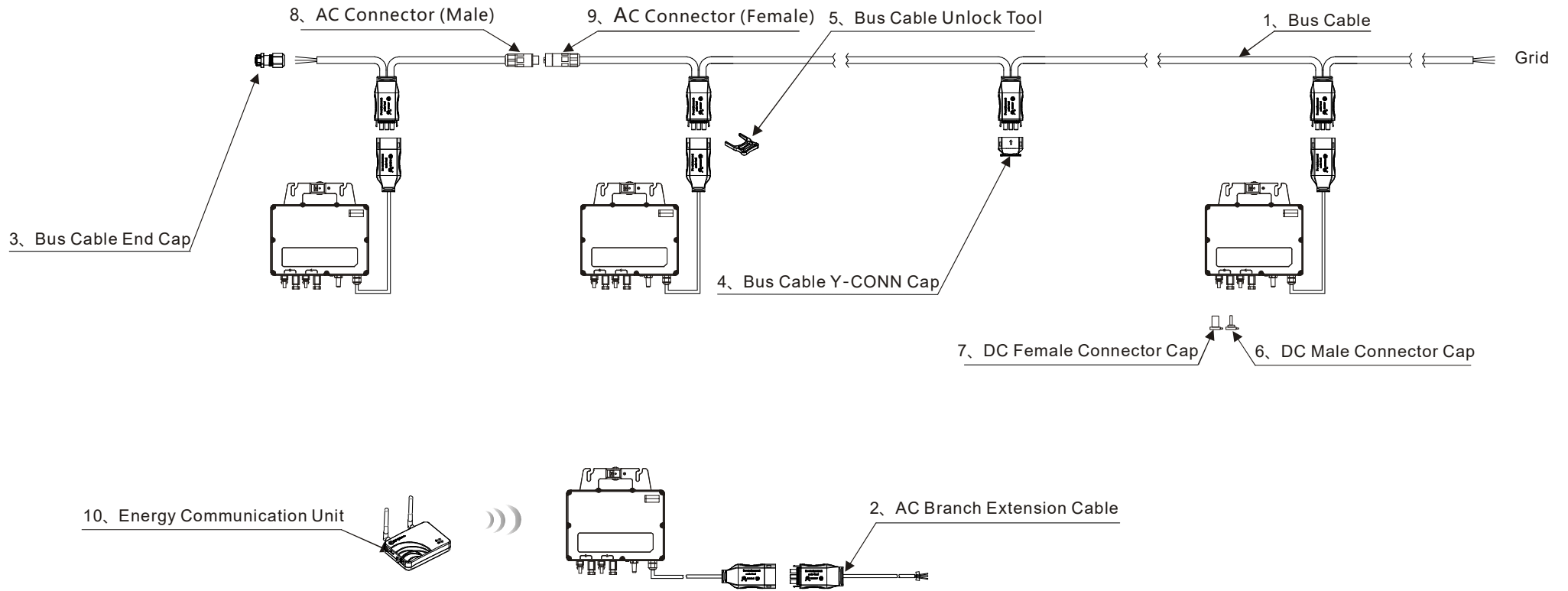

Figure 13

10.YC600B Accessory

10.1 Wiring Diagram



10.2 Accessories Summary

Accessories				
Category	Part NO.	Name	Pic	
1	Bus Cable	2322304903	Y3 Bus Cable(2.5mm ² ,H07RN-F,2m,BN-BU-YL/GN)	
		2322404903	Y3 Bus Cable(2.5mm ² ,H07RN-F,4m,BN-BU-YL/GN)	
2	AC Branch Extension Cable (On demand)	2334076132	Y3 Br. Ext-Cable(2.5mm ² ,H07RN-F,1m,BN-BU-YL/GN)	
3	Bus Cable End Cap (Mandatory)	2060700007	3/4-wire Bus Cable End Cap	
4	Bus Cable Y-CONN Cap (Optional)	2061702007	Bus Cable Y-CONN Cap	
5	Bus Cable Unlock Tool (Mandatory)	2352000001	Y Bus Cable Unlock Tool	
6	DC Male Connector Cap (Optional)	2060401006	DC Male Connector Cap (MC4)	
7	DC Female Connector Cap (Optional)	2060402006	DC Female Connector Cap (MC4)	
8	AC Connector (Male) (Optional)	2300531032	25A AC Male Connector (EN,3-wire)	
9	AC Connector (Female) (Optional)	2300532032	25A AC Female Connector (EN,3-wire)	
10	Energy Communication Unit (Optional)	—	ECU-R (ECU-C)	

APsystems Microinverter & Energy Communication Unit Warranty Card

The APsystems Installation Map is a diagram of the physical location of each microinverter in your PV installation. Each APsystems microinverter has a removable serial number label located on the mounting plate. Peel the label and affix it to the respective location on the APsystems installation map.

Installation Map Template

1	2	3	4	5	6	7	8	9	10	11	12	13	14	15	16	17	18	19	20	21	22